

DENON

INTEGRATED AMPLIFIER

PMA-500AE

OPERATING INSTRUCTIONS

BEDIENUNGSANLEITUNG

MODE D'EMPLOI

ISTRUZIONI PER L'USO

INSTRUCCIONES DE FUNCIONAMIENTO

GEBRUIKSAANWIJZING

BRUKSANVISNING

☐ SAFETY PRECAUTIONS



CAUTION
RISK OF ELECTRIC SHOCK
DO NOT OPEN



CAUTION:

TO REDUCE THE RISK OF ELECTRIC SHOCK, DO NOT REMOVE COVER (OR BACK). NO USER-SERVICEABLE PARTS INSIDE. REFER SERVICING TO QUALIFIED SERVICE PERSONNEL.



The lightning flash with arrowhead symbol, within an equilateral triangle, is intended to alert the user to the presence of uninsulated "dangerous voltage" within the product's enclosure that may be of sufficient magnitude to constitute a risk of electric shock to persons.



The exclamation point within an equilateral triangle is intended to alert the user to the presence of important operating and maintenance (servicing) instructions in the literature accompanying the appliance.

WARNING:

TO REDUCE THE RISK OF FIRE OR ELECTRIC SHOCK, DO NOT EXPOSE THIS APPLIANCE TO RAIN OR MOISTURE.

• DECLARATION OF CONFORMITY

We declare under our sole responsibility that this product, to which this declaration relates, is in conformity with the following standards: EN60065, EN55013, EN55020, EN61000-3-2 and EN61000-3-3. Following the provisions of 73/23/EEC, 89/336/EEC and 93/68/EEC Directive.

• ÜBEREINSTIMMUNGSERKLÄRUNG

Wir erklären unter unserer Verantwortung, daß dieses Produkt, auf das sich diese Erklärung bezieht, den folgenden Standards entspricht: EN60065, EN55013, EN55020, EN61000-3-2 und EN61000-3-3. Entspricht den Verordnungen der Direktive 73/23/EEC, 89/336/EEC und 93/68/EEC.

• DECLARATION DE CONFORMITE

Nous déclarons sous notre seule responsabilité que l'appareil, auquel se réfère cette déclaration, est conforme aux standards suivants: EN60065, EN55013, EN55020, EN61000-3-2 et EN61000-3-3. D'après les dispositions de la Directive 73/23/EEC, 89/336/EEC et 93/68/EEC.

• DICHIARAZIONE DI CONFORMITÀ

Dichiariamo con piena responsabilità che questo prodotto, al quale la nostra dichiarazione si riferisce, è conforme alle seguenti normative: EN60065, EN55013, EN55020, EN61000-3-2 e EN61000-3-3. In conformità con le condizioni delle direttive 73/23/EEC, 89/336/EEC e 93/68/EEC. QUESTO PRODOTTO E' CONFORME AL D.M. 28/08/95 N. 548

• DECLARACIÓN DE CONFORMIDAD

Declaramos bajo nuestra exclusiva responsabilidad que este producto al que hace referencia esta declaración, está conforme con los siguientes estándares: EN60065, EN55013, EN55020, EN61000-3-2 y EN61000-3-3. Siguiendo las provisiones de las Directivas 73/23/EEC, 89/336/EEC y 93/68/EEC.

• EENVORMIGHEIDSVERKLARING

Wij verklaren uitsluitend op onze verantwoordelijkheid dat dit product, waarop deze verklaring betrekking heeft, in overeenstemming is met de volgende normen: EN60065, EN55013, EN55020, EN61000-3-2 en EN61000-3-3. Volgens de bepalingen van de Richtlijnen 73/23/EEC, 89/336/EEC en 93/68/EEC.

• ÖVERENSSTÄMMELSEINTYG

Härmed intygas helt på eget ansvar att denna produkt, vilken detta intyg avser, uppfyller följande standarder: EN60065, EN55013, EN55020, EN61000-3-2 och EN61000-3-3. Enligt stadgarna i direktiv 73/23/EEC, 89/336/EEC och 93/68/EEC.

CAUTION:

To completely disconnect this product from the mains, disconnect the plug from the wall socket outlet. The mains plug is used to completely interrupt the power supply to the unit and must be within easy access by the user.

VORSICHT:

Um dieses Gerät vollständig von der Stromversorgung abzutrennen, trennen Sie bitte den Netzstecker von der Wandsteckdose ab.

Die Hauptstecker werden verwendet, um die Stromversorgung zum Gerät völlig zu unterbrechen; er muss für den Benutzer gut und einfach zu erreichen sein.

PRECAUTION:

Pour déconnecter complètement ce produit du courant secteur, débranchez la prise de la prise murale.

La prise secteur est utilisée pour couper complètement l'alimentation de l'appareil et l'utilisateur doit pouvoir y accéder facilement.

ATTENZIONE:

Per scollegare definitivamente questo prodotto dalla rete di alimentazione elettrica, togliere la spina dalla relativa presa.

La spina di rete viene utilizzata per interrompere completamente l'alimentazione all'unità e deve essere facilmente accessibile all'utente.

PRECAUCIÓN:

Para desconectar completamente este producto de la alimentación eléctrica, desconecte el enchufe del enchufe de la pared.

El enchufe de la alimentación se utiliza para interrumpir por completo el suministro de alimentación a la unidad y debe encontrarse en un lugar al que el usuario tenga fácil acceso.

VOORZICHTIGHEID:

Om de voeding van dit product volledig te onderbreken moet de stekker uit het stopcontact worden getrokken.





De netstekker wordt gebruikt om de stroomtoevoer naar het toestel volledig te onderbreken en moet voor de gebruiker gemakkelijk bereikbaar zijn.

FÖRSIKTIHETSMÅTT:

Koppla loss stickproppen från eluttaget för att helt skilja produkten från nätet.

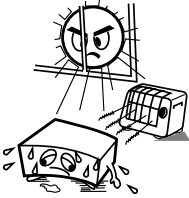
Stickproppen används för att helt bryta strömförsörjningen till apparaten, och den måste vara lättillgänglig för användaren.

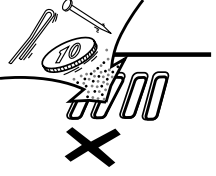
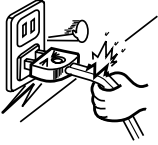
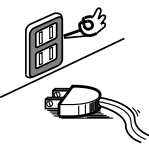
☐ NOTE ON USE / HINWEISE ZUM GEBRAUCH / OBSERVATIONS RELATIVES A L'UTILISATION / NOTE SULL'USO / NOTAS SOBRE EL USO / ALVORENS TE GEBRUIKEN / OBSERVERA

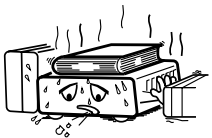
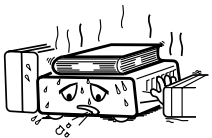
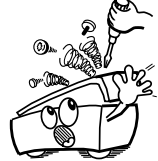
 <ul style="list-style-type: none"> • Avoid high temperatures. Allow for sufficient heat dispersion when installed in a rack. • Vermeiden Sie hohe Temperaturen. Beachten Sie, daß eine ausreichend Luftzirkulation gewährleistet wird, wenn das Gerät auf ein Regal gestellt wird. • Eviter des températures élevées. Tenir compte d'une dispersion de chaleur suffisante lors de l'installation sur une étagère. • Evitate di esporre l'unità a temperature alte. Assicuratevi che ci sia un'adeguata dispersione del calore quando installate l'unità in un mobile per componenti audio. • Evite altas temperaturas. Permite la suficiente dispersión del calor cuando está instalado en la consola. • Vermijd hoge temperaturen. Zorg voor een degelijk hitteafvoer indien het apparaat op een rek wordt geplaatst. • Undvik höga temperaturer. Se till att det finns möjlighet till god värmeavledning vid monteringen i ett rack. 	 <ul style="list-style-type: none"> • Keep the apparatus free from moisture, water, and dust. • Halten Sie das Gerät von Feuchtigkeit, Wasser und Staub fern. • Protéger l'appareil contre l'humidité, l'eau et la poussière. • Tenete l'unità lontana dall'umidità, dall'acqua e dalla polvere. • Mantenga el equipo libre de humedad, agua y polvo. • Laat geen vochtigheid, water of stof in het apparaat binnendringen. • Utsätt inte apparaten för fukt, vatten och damm. 	 <ul style="list-style-type: none"> • Do not let foreign objects into the apparatus. • Keine fremden Gegenstände in das Gerät kommen lassen. • Ne pas laisser des objets étrangers dans l'appareil. • E' importante che nessun oggetto è inserito all'interno dell'unità. • No deje objetos extraños dentro del equipo. • Laat geen vreemde voorwerpen in dit apparaat vallen. • Se till att främmande föremål inte tränger in i apparaten. 	<p>CAUTION:</p> <ul style="list-style-type: none"> • The ventilation should not be impeded by covering the ventilation openings with items, such as newspapers, tablecloths, curtains, etc. • No naked flame sources, such as lighted candles, should be placed on the apparatus. • Attention should be drawn to the environmental aspects of battery disposal. • Do not expose the set to dripping or splashing fluids. • No objects filled with liquids, such as vases, shall be placed on the apparatus. <p>ACHTUNG:</p> <ul style="list-style-type: none"> • Die Belüftung sollte auf keinen Fall durch das Abdecken der Belüftungsöffnungen durch Gegenstände wie beispielsweise Zeitungen, Tischtücher, Vorhänge o. Ä. behindert werden. • Auf dem Gerät sollten keinerlei direkten Feuerquellen wie beispielsweise angezündete Kerzen aufgestellt werden. • Bitte beachten Sie bei der Entsorgung der Batterien die geltenden Umweltbestimmungen. • Das Gerät sollte keinerlei Flüssigkeit, also keinem Tropfen oder Spritzen ausgesetzt werden. • Auf dem Gerät sollten keinerlei mit Flüssigkeit gefüllten Behälter wie beispielsweise Vasen aufgestellt werden.
 <ul style="list-style-type: none"> • Handle the power cord carefully. Hold the plug when unplugging the cord. • Gehen Sie vorsichtig mit dem Netzkabel um. Halten Sie das Kabel am Stecker, wenn Sie den Stecker herausziehen. • Manipuler le cordon d'alimentation avec précaution. Tenir la prise lors du débranchement du cordon. • Maneggiare il filo di alimentazione con cura. Agitare per la spina quando scollegate il cavo dalla presa. • Maneje el cordón de energía con cuidado. Sostenga el enchufe cuando desconecte el cordón de energía. • Hanteer het netsnoer voorzichtig. Houd het snoer bij de stekker vast wanneer deze moet worden aan- of losgekoppeld. • Hantera nätkabeln varsamt. Håll i kabeln när den kopplas från el-uttaget. 	 <ul style="list-style-type: none"> • Unplug the power cord when not using the apparatus for long periods of time. • Wenn das Gerät eine längere Zeit nicht verwendet werden soll, trennen Sie das Netzkabel vom Netzstecker. • Débrancher le cordon d'alimentation lorsque l'appareil n'est pas utilisé pendant de longues périodes. • Disinnestate il filo di alimentazione quando avete l'intenzione di non usare il filo di alimentazione per un lungo periodo di tempo. • Desconecte el cordón de energía cuando no utilice el equipo por mucho tiempo. • Neem altijd het netsnoer uit het stopcontact wanneer het apparaat gedurende een lange periode niet wordt gebruikt. • Koppla ur nätkabeln om apparaten inte kommer att användas i lång tid. 	 <ul style="list-style-type: none"> • Do not let insecticides, benzene, and thinner come in contact with the apparatus. • Lassen Sie das Gerät nicht mit Insektiziden, Benzin oder Verdünnungsmitteln in Berührung kommen. • Ne pas mettre en contact des insecticides, du benzène et un diluant avec l'appareil. • Assicuratevvi che l'unità non venga in contatto con insetticidi, benzolo o solventi. • No permita el contacto de insecticidas, gasolina y diluyentes con el equipo. • Laat geen insectenverdelgende middelen, benzine of verfverdunder met dit apparaat in contact komen. • Se till att inte insektsmedel på spraybruk, bensen och thinner kommer i kontakt med apparatens hölje. 	<p>ATTENTION:</p> <ul style="list-style-type: none"> • La ventilation ne doit pas être gênée en recouvrant les ouvertures de la ventilation avec des objets tels que journaux, rideaux, tissus, etc. • Aucune flamme nue, par exemple une bougie, ne doit être placée sur l'appareil. • Veillez à respecter l'environnement lorsque vous jetez les piles usagées. • L'appareil ne doit pas être exposé à l'eau ou à l'humidité. • Accun objet contenant du liquide, par exemple un vase, ne doit être placé sur l'appareil. <p>PRECAUZIONI:</p> <ul style="list-style-type: none"> • Le aperture di ventilazione non devono essere ostruite coprendole con oggetti, quali giornali, tovaglie, tende e così via. • Non posizionare sull'apparechiatura fiamme libere, come ad esempio le candele accese. • Prestare attenzione agli aspetti legati alla tutela dell'ambiente quando si smaltisce la batteria. • L'apparechiatura non deve essere esposta a gocciolii o spruzzi. • Non posizionare sull'apparechiatura nessun oggetto contenete liquidi, come ad esempio i vasi. <p>PRECAUCIÓN:</p> <ul style="list-style-type: none"> • La ventilación no debe quedar obstruida por hacerse cubierto las aperturas con objetos como periódicos, manteles, cortinas, etc. • No debe colocarse sobre el aparato ninguna fuente inflamable sin protección, como velas encendidas. • A la hora de deshacerse de las pilas, respete la normativa para el cuidado del medio ambiente. • No se expondrá el aparato al goteo o salpicaduras cuando se utilice. • No se colocarán sobre el aparato objetos llenos de líquido, como jarras.
 <p>* (For apparatuses with ventilation holes)</p> <ul style="list-style-type: none"> • Do not obstruct the ventilation holes. • Die Belüftungsöffnungen dürfen nicht verdeckt werden. • Ne pas obstruer les trous d'aération. • Non coprite i fori di ventilazione. • No obstruya los orificios de ventilación. • De ventilatieopeningen mogen niet worden beblokkeerd. • Täpp inte till ventilationsöppningarna. 	 <p>* (For apparatuses with ventilation holes)</p> <ul style="list-style-type: none"> • Do not obstruct the ventilation holes. • Die Belüftungsöffnungen dürfen nicht verdeckt werden. • Ne pas obstruer les trous d'aération. • Non coprite i fori di ventilazione. • No obstruya los orificios de ventilación. • De ventilatieopeningen mogen niet worden beblokkeerd. • Täpp inte till ventilationsöppningarna. 	 <ul style="list-style-type: none"> • Never disassemble or modify the apparatus in any way. • Versuchen Sie niemals das Gerät auseinander zu nehmen oder auf jegliche Art zu verändern. • Ne jamais démonter ou modifier l'appareil d'une manière ou d'une autre. • Non smontate mai, nè modificate l'unità in nessun modo. • Nunca desarme o modifique el equipo de ninguna manera. • Nooit dit apparaat demonteren of op andere wijze modificeren. • Ta inte isär apparaten och försök inte bygga om den. 	<p>WAARSCHUWING:</p> <ul style="list-style-type: none"> • De ventilatie mag niet worden belemmerd door de ventilatieopeningen af te dekken met bijvoorbeeld kranten, een tafelkleed, gordijnen, enz. • Plaats geen open vlammen, bijvoorbeeld een brandende kaars, op het apparaat. • Houd u steeds aan de milieuvorschriften wanneer u gebruikte batterijen wegdoet. • Stel het apparaat niet bloot aan druppels of spatten. • Plaats geen voorwerpen gevuld met water, bijvoorbeeld een vaas, op het apparaat. <p>OBSERVERA:</p> <ul style="list-style-type: none"> • Ventilationen bör inte förhindras genom att täcka för ventilationsöppningarna med föremål såsom tidningar, bordsdukar, gardiner osv. • Inga blottade brandkällor, såsom tända ljus, bör placeras på apparaten. • Tänk på miljöaspekterna när du bortskaffar batteri. • Apparaten får inte utsättas för vätska. • Inga objekt med vätskor, såsom vasor, får placeras på apparaten.

A NOTE ABOUT RECYCLING:

This product's packaging materials are recyclable and can be reused. Please dispose of any materials in accordance with the local recycling regulations.

When discarding the unit, comply with local rules or regulations.

Batteries should never be thrown away or incinerated but disposed of in accordance with the local regulations concerning chemical waste.

This product and the accessories packed together constitute the applicable product according to the WEEE directive except batteries.

**HINWEIS ZUM RECYCLING:**

Das Verpackungsmaterial dieses Produktes ist für zum Recyceln geeignet und kann wieder verwendet werden. Bitte entsorgen Sie alle Materialien entsprechend der örtlichen Recycling-Vorschriften.

Beachten Sie bei der Entsorgung des Gerätes die örtlichen Vorschriften und Bestimmungen.

Die Batterien dürfen nicht in den Hausmüll geworfen oder verbrannt werden; bitte geben Sie die Batterien gemäß örtlichen Bestimmungen an den Sammelstellen oder Sondermüllplätzen ab.

Dieses Produkt zusammen mit den Zubehörteilen ist das geltende Produkt der WEEE-Direktive, davon ausgenommen sind die Batterien.

UNE REMARQUE CONCERNANT LE RECYCLAGE:

Les matériaux d'emballage de ce produit sont recyclables et peuvent être réutilisés. Veuillez disposer de tout matériau conformément aux règlements de recyclage locaux.

Lorsque vous mettez cet appareil au rebut, respectez les lois ou réglementations locales.

Les piles ne doivent jamais être jetées ou incinérées, mais mises au rebut conformément aux règlements locaux concernant les déchets chimiques.

Ce produit et les accessoires emballés ensemble sont des produits conformes à la directive DEEE sauf pour les piles.

NOTA RELATIVA AL RICICLAGGIO:

I materiali di imballaggio di questo prodotto sono riutilizzabili e riciclabili. Smaltire i materiali conformemente alle normative locali sul riciclaggio.

Per smaltire l'unità, osservare la normativa in vigore nel luogo di utilizzo.

Non gettare le batterie, né incenerirle, ma smaltirle conformemente alla normativa locale sui rifiuti chimici.

Questo prodotto e gli accessori inclusi nell'imballaggio sono applicabili alla direttiva RAEE, ad eccezione delle batterie.

ACERCA DEL RECICLAJE:

Los materiales de embalaje de este producto son reciclables y se pueden volver a utilizar. Disponga de estos materiales siguiendo los reglamentos de reciclaje de su localidad.

Cuando se deshaga de la unidad, cumpla con las reglas o reglamentos locales.

Las pilas nunca deberán tirarse ni incinerarse. Deberá disponer de ellas siguiendo los reglamentos de su localidad relacionados con los desperdicios químicos.

Este producto junto con los accesorios empaquetados es el producto aplicable a la directiva RAEE excepto pilas.

EEN AANTEKENING WAT BETREFT HET RECYCLEREN:

Het inpakmateriaal van dit product is recycleerbaar en kan opnieuw gebruikt worden. Er wordt verzocht om zich van elk afvalmateriaal te ontdoen volgens de plaatselijke voorschriften.

Volg voor het wegdoen van de speler de voorschriften voor de verwijdering van wit- en bruingoed op.

Batterijen mogen nooit worden weggegooid of verbrand, maar moeten volgens de plaatselijke voorschriften betreffende chemisch afval worden verwijderd.

Op dit product en de meegeleverde accessoires, m.u.v. de batterijen is de richtlijn voor afgedankte elektrische en elektronische apparaten (WEEE) van toepassing.

EN KOMMENTAR OM ÅTERVINNING:

Produktens emballage är återvinningsbart och kan återanvändas. Kassera det enligt lokala återvinningsbestämmelser.

När du kasserar enheten ska du göra det i överensstämmelse med lokala regler och bestämmelser.

Batterier får absolut inte kastas i soporna eller brännas. Kassera dem enligt lokala bestämmelser för kemiskt avfall.

Denna apparat och de tillbehör som levereras med den är de som uppfyller gällande WEEE-direktiv, med undantag av batterierna.

Getting Started

Thank you for choosing the DENON PMA-500AE Pre-main Amplifier. This remarkable component has been engineered to provide superb sound, as well as providing outstanding high fidelity reproduction of your favorite music sources.

As this product is provided with an immense array of features, we recommend that before you begin hookup and operation that you review the contents of this manual before proceeding.

Contents

Getting Started

Accessories	1
Cautions on installation	1
Cautions on using mobile phones	1
Before using	1
About the remote control unit	1
Inserting the batteries	2
Operating range of the remote control unit	2
Part names and functions	
Front panel	2, 3
Rear panel	3
Remote control unit	3

Connections

Connecting the speakers	4
Connecting the Audio Equipment	4
Cable indications	4
Connecting Players and Speakers	5
Connecting Recorders	5
Connecting the power supply cord	5

Operation

Preparations prior to playing	6
Starting playback	6
Starting recording	6
Copying cassette tapes	6

Troubleshooting	7
-----------------------	---

Specifications	7
----------------------	---

Accessories

Check that the following parts are attached in addition to the main unit:

- ① Operating instructions 1
- ② Service station list 1
- ③ Remote control unit (RC-1022) 1
- ④ Batteries (R03/AAA) 2

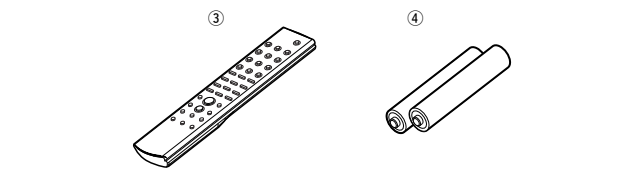

Cautions on installation

Note:

For heat dispersal, do not install this unit in a confined space such as a bookcase or similar enclosure.

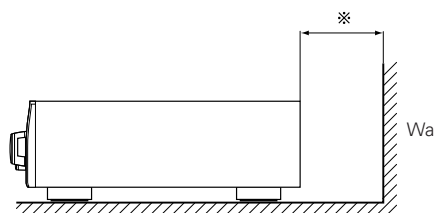
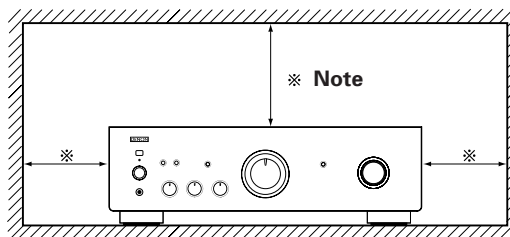

Cautions on using mobile phones

Using a mobile phone near this unit may result in noise. If so, move the mobile phone away from this unit when it is in use.

Before using

Pay attention to the following before using this unit:

• Moving the set.

To prevent short-circuits or damaged wires in the connection cables, always unplug the power supply cord and disconnect the connection cables between all other audio components when moving the unit.

• Before turning the power switch on.

Check once again that all connections are correct and that there are not problems with the connection cables. Always set the power switch to the standby position before connecting and disconnecting connection cables.

• Store the operating instructions in a safe place.

After reading the operating instructions, store them in a safe place as they could come in handy in the future.

• Whenever the power switch is in the STANDBY state, the unit is still connected to AC line voltage.

Please be sure to turn off the power switch or unplug the cord when you leave home for, say, a vacation.

• Note that the illustrations in these instructions may differ from the actual unit for explanation purposes.

About the remote control unit

The included remote control unit can be used to control DENON CD players, tape decks and tuners.

※ Some products may not be operable.

Getting Started

Inserting the batteries

- 1 Remove the remote control unit's rear cover.

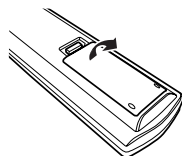

- 2 Set two R03/AAA batteries in the battery compartment in the indicated direction.

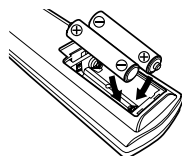

- 3 Put the rear cover back on.

Notes on batteries:

- Replace the batteries with new ones if the set does not operate even when the remote control unit is operated nearby the unit. (The attached batteries are only for verifying operation.)
- When inserting the batteries, be sure to do so in the proper direction, following the “+” and “-” marks in the battery compartment.
- To prevent damage or leakage of battery fluid:
 - Do not use a new battery together with an old one.
 - Do not use two different types of batteries.
 - Do not short-circuit, disassemble, heat or dispose of batteries in flames.
- If the battery fluid should leak, carefully wipe the fluid off the inside of the battery compartment and insert new batteries.
- Remove the batteries from the remote if it will not be in use for long periods.

Operating range of the remote control unit

- Point the remote control unit at the remote sensor when operating it.
- The remote control unit can be used from a distance of up to about 8 meters, at a horizontal angle of up to 30° with respect to the sensor.

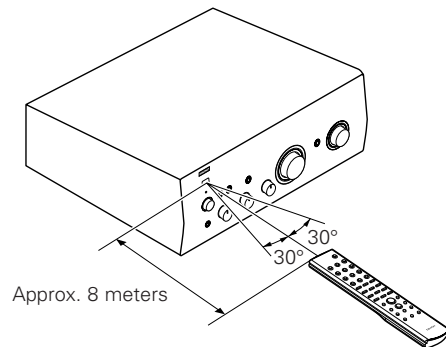

NOTE:

- It may be difficult to operate the remote control unit if the remote sensor is exposed to direct sunlight or strong artificial light.

Getting Started

Part names and functions

Front panel

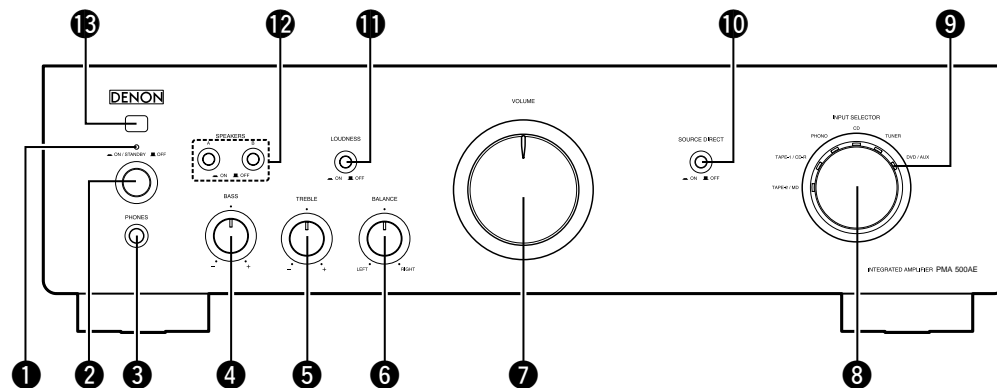

- 1 **Power indicator**
Changes as shown below according to this unit's status.
 - For several seconds after the power is turned on: Red (blinking)
 - When the power is on: Green
 - When in standby: Red
 - When the power is off: Off
- 2 **Power switch (ON/STANDBY OFF)**
When set to “ON/STANDBY”, the power turns on, and when set to “OFF”, the power turns off.
- 3 **Headphone jack (PHONES)**
- 4 **BASS control knob**
- 5 **TREBLE control knob**
- 6 **BALANCE control knob**
- 7 **VOLUME control knob**
- 8 **INPUT SELECTOR knob**
Use this to select the source that you wish to listen to.
- 9 **Input indicator**
The selected input is shown with an orange indicator.
- 10 **SOURCE DIRECT switch**
When set to “ON”, the signals do not pass through the tone adjustment circuitry (bass, treble, balance and loudness), resulting in playback with higher sound quality. When set to “OFF”, the sound can be adjusted to your tastes.
- 11 **LOUDNESS switch**
When listening with the volume turned low, set this to “ON” to amplify the bass and treble sound that is hard to hear when the volume is low and achieve a more natural sound.
- 12 **SPEAKERS A/B switches**
 - When A (or B) is set to “ON”, sound is produced from the speakers connected to the A (or B) speaker output terminals.
 - When both A and B are set to “ON”, sound is produced from the speakers connected to both the A and B speaker output terminals.
 - When both A and B are set to “OFF”, no sound is produced from the speakers. Use this when listening over headphones.
- 13 **Remote control sensor**

Getting Started



- When the **VOLUME** control knob is set just beyond the “12 o’clock” position (over halfway), the adjustments that can be made with the **BASS** and **TREBLE** controls is decreased.
- When the **VOLUME** control knob is set to maximum or turned fully clockwise, the base and treble can no longer be adjusted.

NOTE:

- Functions **4**, **5**, **6** and **11** are only available when the **SOURCE DIRECT** switch is set to “OFF”.

Rear panel

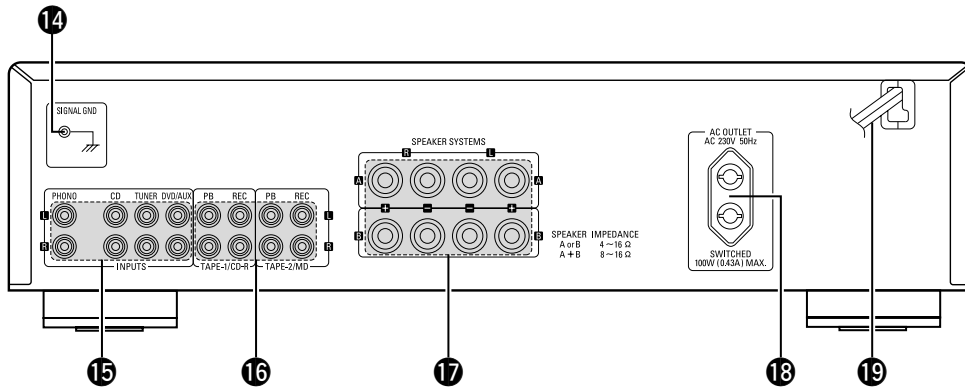

14 SIGNAL GND (ground) terminal

Connect the ground wire from your turntable here.

NOTE:

- This terminal is not a safety ground.

15 Input terminals (INPUTS)

Connect your source equipment here.

16 Recording input/output terminals (TAPE-1/CD-R and TAPE-2/MD)

Connect your recording equipment here.

17 Speaker system terminals (SPEAKER SYSTEMS)

Connect your speakers here.

18 AC OUTLET

Use this as the power outlet for other audio devices. Check equipment power requirement ratings before use (see the ratings as marked on the rear panel). If in doubt consult with your dealer or DENON distributor.

19 Power supply cord



- Short-circuiting plugs are inserted into the PHONO input terminals. Remove these when connecting a turntable. Be sure to keep it for future use.

Getting Started

Remote control unit

Amplifier operating buttons

POWER button
This operates the main unit's power.

Input source selector buttons
These switch the input source.

MUTING button
Press this to mute the sound. The power indicator on the main unit blinks red. Press again to produce sound.

Volume adjust buttons
These adjust the volume.

DENON product operating buttons

CD player block
0-9, +10 : Number buttons
REPEAT : Repeat playback
RANDOM : Random playback
◀◀, ▶▶ : Search
▶ : Play
⏸ : Pause
■ : Stop

CD player block
DISC SKIP
This button selects the disc, when using a DENON multi-disc CD player.

TUNER block
TUNER PRESET ▲, ▼
These switch the preset channel.

Tape deck block
◀◀ : Rewind
▶▶ : Fast-forward
◀ : Reverse play
▶ : Forward play
A/B : Switch between decks
A and B for double decks
REC : Record
⏸ : Pause
■ : Stop

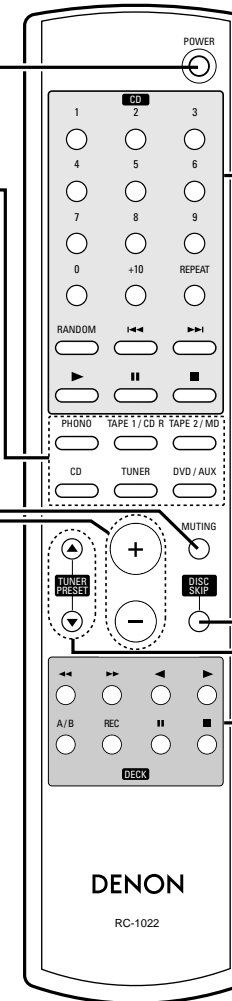

- The included remote control unit can be used to operate DENON CD players, tape decks and tuners.
- When using it, also refer to the operating instructions of the other devices.
- Some products may not be operable.

Connections

Connecting the speakers

Connect the speaker terminals with the speakers making sure that like polarities are matched (⊕ with ⊕, ⊖ with ⊖).

Connecting the speaker cables

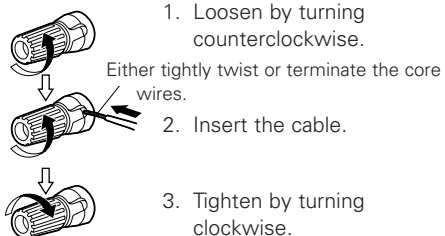

NOTE:
 When making connections, take care that none of the individual conductors of the speaker cable come in contact with adjacent terminals, with other speaker cable conductors, or with the rear panel and screws.
 NEVER touch the speaker terminals when the power is on. Doing so could result in electric shocks.

Speaker impedance

Use speakers with impedances within the ranges shown below according to their usage conditions.

Speakers used	Impedance
A or B	4 ~ 16 Ω/ohms
A and B	8 ~ 16 Ω/ohms

Note on speaker impedance

When using speakers with an impedance below the designated value (for example 4 Ω/ohms), playing for long periods of time with the volume high could cause the temperature to rise, activating the protection circuit.

When the protection circuit is activated, the output to the speakers is cut off and the power indicator blinks. If this happens, unplug the power cord, wait for the set to cool off and improve ventilation around the unit. Also check the wiring of the input cables and the speaker cables. After doing this, plug the power cord back in and turn the unit's power back on.

If the protection circuit is activated again even though there are no problems with the wiring or the ventilation around the unit, switch off the power and contact a DENON service center.

Connecting the Audio Equipment

NOTE:

- Do not plug in the power supply cord until all connections have been completed.
- When making connections, also refer to the operating instructions of the other components.
- Be sure to connect the left and right channels properly (left with left, right with right).
- Do not bundle power cords together with speaker cables. Doing so could result in humming or noise.
- Do not turn up the volume when no turntable is connected to the PHONO input terminals. Doing so will cause humming or noise. When not connecting a turntable, leave the included short-circuiting pin plug plugged in.

Cautions on playing SA sources:

When regular speakers not compatible with SA sources (DVD Audio discs, Super Audio CDs and other sources including treble components above the audible range), set the properties of the player (DVD Audio player, Super Audio CD player, etc.) for use with regular speakers (or amplifiers).

The speakers may be damaged if the volume is set too high when playing SA sources.

For instructions on setting the player, refer to the operating instructions included with the player.

Cable indications

The hookup diagrams on the subsequent pages assume the use of the following optional connection cables (not supplied).

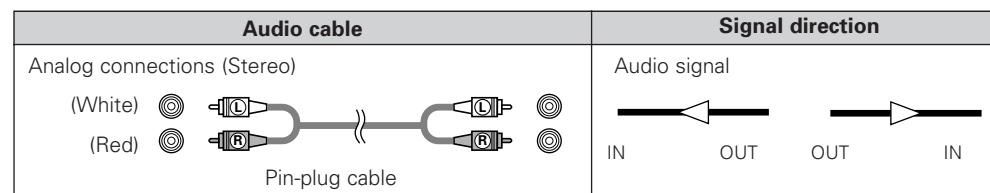

Connections

Connecting Players and Speakers

- Only Turntables fitted with a MM (Moving Magnet) cartridge can be used with this unit. If you have an MC (Moving Coil) cartridge you will need to use a commercially available head amplifier or step-up transformer.
- If humming or other noise is generated when the ground wire is connected, disconnect it.

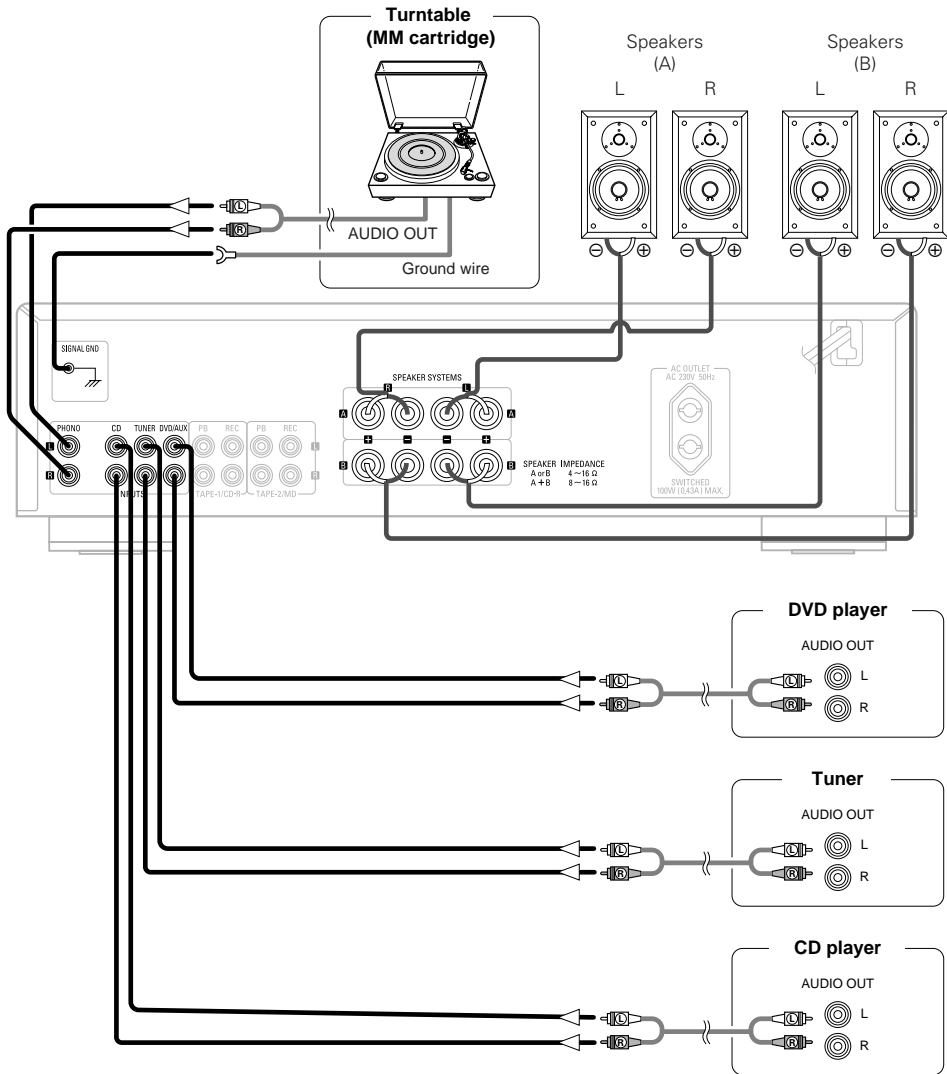

Connections

Connecting Recorders

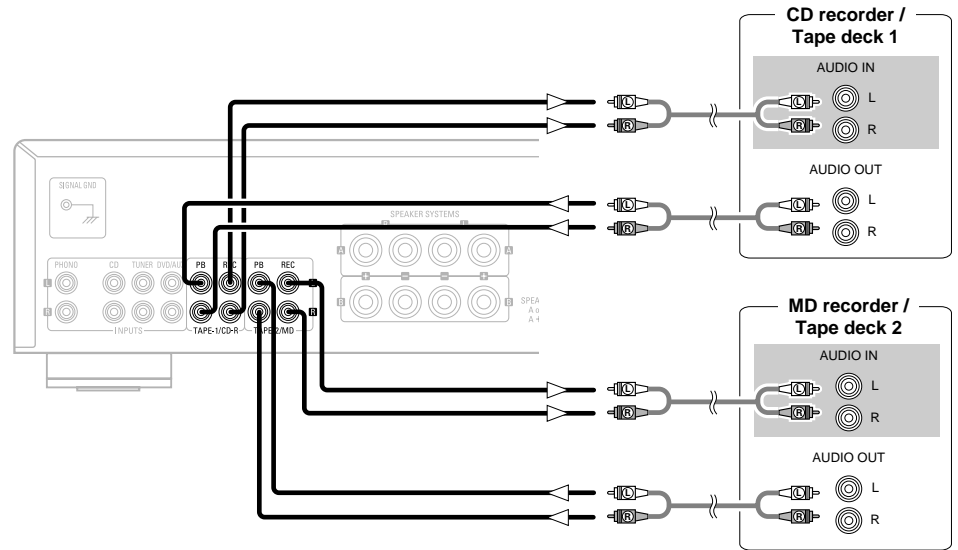

Connecting the power supply cord

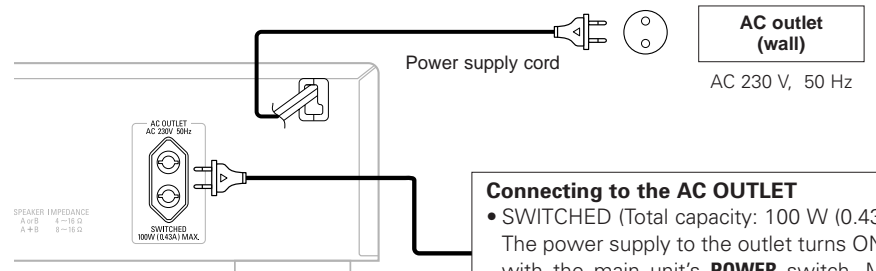

Connecting to the AC OUTLET

- **SWITCHED** (Total capacity: 100 W (0.43 A):
The power supply to the outlet turns ON and OFF with the main unit's **POWER** switch. Make sure the total power consumption of the connected devices does not exceed 100W (0.43 A).

NOTE:

- Only use the AC OUTLET for audio equipment. Never use it for hair driers, TVs or other electrical appliances.
- Insert the plugs securely. Incomplete connections will result in the generation of noise.

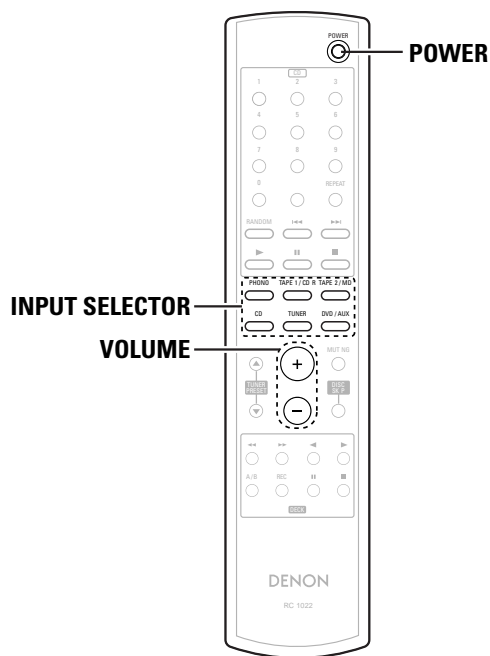
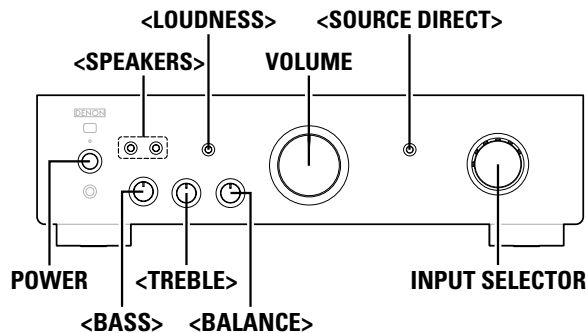

About the button names in this explanation
 < > : Buttons on the main unit
 [] : Buttons on the remote control unit
Button name only :
 Buttons on the main unit and remote control unit

Operation

Preparations prior to playing

- 1** Set the volume to the minimum by using **VOLUME**.
- 2** Set **<SOURCE DIRECT>** and **<LOUDNESS>** to “OFF”.
- 3** Set **<BASS>**, **<TREBLE>** and **<BALANCE>** to the center position.
- 4** Press **<SPEAKERS>** **A** or **B** depending on the terminals to which speakers are connected.
- 5** Turn on the power by pressing **POWER**.
 - The power indicator blinks red for several seconds, then lights green.

Starting playback

- 1** Use **INPUT SELECTOR** to select the source to be played.
 - Select one of the sources among the following: TAPE-2/MD, TAPE-1/CD-R, PHONO, CD, TUNER and DVD/AUX.
 - The input indicator for the selected source lights.
- 2** Play the selected source.
- 3** Adjust the volume by using **VOLUME**.
- 4** Adjust the tone with **<BASS>**, **<TREBLE>**, **<BALANCE>** and **<LOUDNESS>**.
 - ※ If there is no need to adjust the tone, press **<SOURCE DIRECT>**.

Starting recording

- 1** Turn **<INPUT SELECTOR>** to select the source to be recorded.
 - PHONO, CD, TUNER, DVD/AUX:**
Select the device connected to the recording terminals to record.
- 2** Set the recorder to the record mode.
- 3** Start playing the source to be recorded.

Copying cassette tapes

- 1** Turn **<INPUT SELECTOR>** and select “TAPE-1/CD-R” (or “TAPE-2/MD”).
 - TAPE-1/CD-R, TAPE-2/MD:**
Select this to record from tape deck 1 onto tape deck 2 (or from tape deck 2 onto tape deck 1).
- 2** Set the device connected to the **TAPE-1/CD-R** (or **TAPE-2/MD**) terminal to the record mode.
- 3** Start playback on the device connected to the **TAPE-2/MD** (or **TAPE-1/CD-R**) terminal.



• When performing these operations, also refer to the operating instructions of the other devices.

Troubleshooting

Check the following before assuming there is a problem with the set

1. Are all connections proper ?
2. Is the set being operated as described in the operating instructions ?
3. Are the speakers and input components being operated properly ?

If the set does not seem to be operating properly, check the points listed below. If these points do not apply, the set may be damaged. Turn off the power immediately and contact your store of purchase.

Symptom	Cause	Measures	Page
When the power is turned on, the power indicator does not light and no sound is produced.	<ul style="list-style-type: none"> The power supply cord's plug is not fully plugged in. 	<ul style="list-style-type: none"> Make sure the unit is correctly plugged in and switched on at the mains socket. 	5
The power indicator lights but no sound is produced.	<ul style="list-style-type: none"> The speaker cables are not fully connected. The device you want to listen to has not been selected. 	<ul style="list-style-type: none"> Connect securely. 	4, 5
		<ul style="list-style-type: none"> Insure the correct input is selected. 	2, 6
	<ul style="list-style-type: none"> The volume control is set to minimum. The input cable is not fully connected. The speaker selector button is set to "OFF". 	<ul style="list-style-type: none"> Set to an appropriate level. 	2, 6
		<ul style="list-style-type: none"> Connect securely. Ensure the SPEAKER A or B buttons are set to "ON" as appropriate. 	5 2, 6
Sound is only produced from the left or right speaker(s).	<ul style="list-style-type: none"> The speaker cables are not fully connected. The input cable is not fully connected. The left/right balance is off. 	<ul style="list-style-type: none"> Connect securely. 	4, 5
		<ul style="list-style-type: none"> Connect securely. Adjust to a proper balance using the balance control knob. 	5 2
	<ul style="list-style-type: none"> The connections of the speakers or input cables are inverted. 	<ul style="list-style-type: none"> Check the connections to be sure that left is connected to left, right to right. 	4, 5
Humming sound is heard in the music when playing records.	<ul style="list-style-type: none"> The player's ground wire is not connected. 	<ul style="list-style-type: none"> Connect securely. 	3, 5
	<ul style="list-style-type: none"> The cables are not fully connected to the PHONO terminals. 	<ul style="list-style-type: none"> Connect securely. 	3, 5
	<ul style="list-style-type: none"> Influence from a TV or VCR near the player. 	<ul style="list-style-type: none"> Try changing the positions in which the devices are installed. 	-
Howling is produced along with the music if the volume is too high when playing records.	<ul style="list-style-type: none"> The player and speakers are too close together. 	<ul style="list-style-type: none"> Install the player and speakers as far from each other as possible. 	-
	<ul style="list-style-type: none"> The vibrations from the speakers are being transmitted to the player through the floor. 	<ul style="list-style-type: none"> Use cushions, etc., to absorb the speakers' vibrations. 	-
When playing a record, the sound is distorted.	<ul style="list-style-type: none"> The needle pressure is not proper. 	<ul style="list-style-type: none"> Adjust to a proper needle pressure. 	-
	<ul style="list-style-type: none"> There is dirt on the tip of the needle. 	<ul style="list-style-type: none"> Check the tip of the needle. 	-
	<ul style="list-style-type: none"> The cartridge is defective. 	<ul style="list-style-type: none"> Replace the cartridge. 	-

Specifications

Power amplifier section

Rated Output Power:

2-channel driving (CD → SP OUT)
45 W + 45 W (8 Ω/ohms, 20 Hz ~ 20 kHz, T.H.D. 0.07 %)

Dynamic power:

70 W + 70 W (4 Ω/ohms, DIN, 1 kHz, T.H.D. 0.7 %)

High frequency distortion:

0.02 % (Rated output: -3 dB), 8 Ω/ohms, 1 kHz

Output terminals:

Speaker A or B: 4 ~ 16 Ω/ohms
A + B: 8 ~ 16 Ω/ohms

Suited for headphones/stereo headphones

Pre amplifier section

Equalizer amplifier output: (REC OUT terminals)

150 mV

Input Sensitivity/Input Impedance:

PHONO (MM): 2.5 mV/47 kΩ/kohms
CD, TUNER, DVD/AUX, TAPE-1/CD-R, TAPE-2/MD:
100 mV/16 kΩ/kohms (SOURCE DIRECT OFF)
100 mV/16 kΩ/kohms (SOURCE DIRECT ON)

RIAA Deviation:

PHONO (MM): 20 Hz ~ 20 kHz±0.5 dB

Overall performance

SN Ratio (A network):

PHONO (MM): 84 dB
(With input terminals short-circuited, 5 mV input signal)
CD, TUNER, DVD/AUX, TAPE-1/CD-R, TAPE-2/MD:
105 dB (input terminals short-circuited)

Tone control (bass):

BASS: 100 Hz±8 dB
TREBLE: 10 kHz±8 dB

LOUDNESS:

100 Hz: +6 dB, 10 kHz: +6 dB

General

Power outlet:

1 switched outlet, total capacity 100 W (0.43 A)

Power Supply:

AC 230 V, 50 Hz

Power Consumption:

185 W (IEC)

Dimensions:

434 (W) x 121 (H) x 307 (D) mm (including protruding parts)

Net Mass:

6.5 kg

Remote control unit (RC-1022)

Remote control type:

Infrared pulse

Power supply:

R03/AAA Type (2 batteries)

External dimensions:

49 (W) x 220 (H) x 21 (D) mm

Mass:

120 g (including batteries)

* For improvement purposes, specifications and functions are subject to change without advanced notice.

DENON

TOKYO, JAPAN
www.denon.com

Denon Brand Company, D&M Holdings Inc.
Printed in China 00D 511 4554 007